

# Beginning Consonants

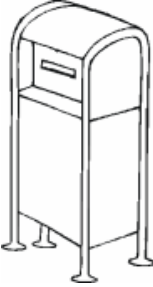

Say the letter at the beginning of each row. Trace the letter and then write the letter on the line.

Color the picture that begins with the sound of the letter in each row.

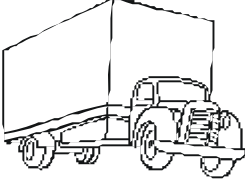
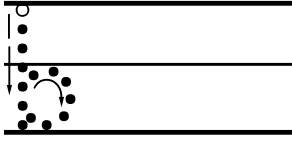

**b**



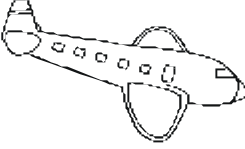
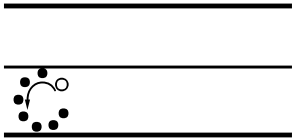

**c**

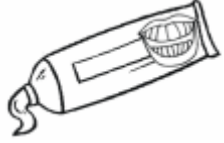

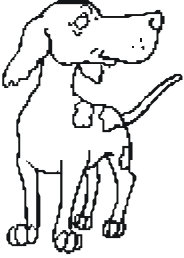
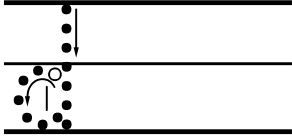
**d**



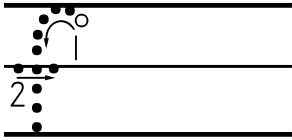

**f**



# Beginning Consonants

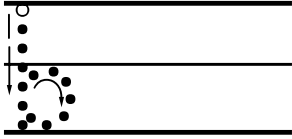

Say the letter at the beginning of each row. Trace the letter and then write the letter on the line.

Color the picture that begins with the sound of the letter in each row.

**b**  

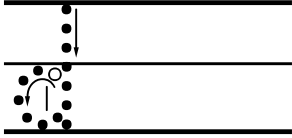
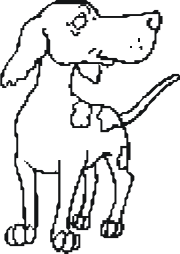
**c**  

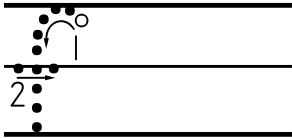
**d**  





**f**  

# Beginning Consonants

Say the letter at the beginning of each row. Trace the letter and then write the letter on the line.

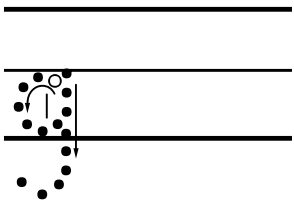
Color the picture that begins with the sound of the letter in each row.

g





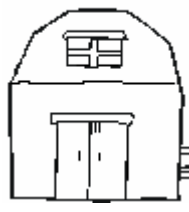

h



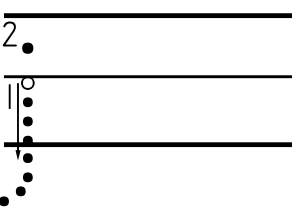
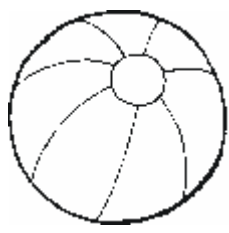
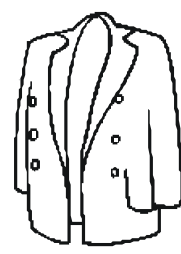





j

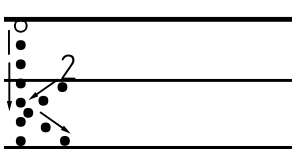
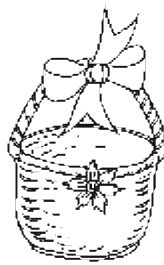

k





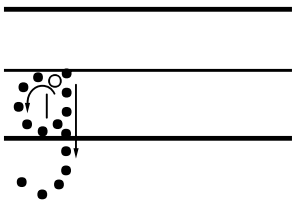

# Beginning Consonants

Say the letter at the beginning of each row. Trace the letter and then write the letter on the line.

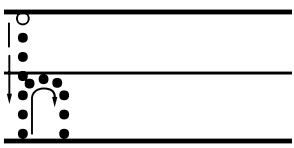
Color the picture that begins with the sound of the letter in each row.

g  

h  

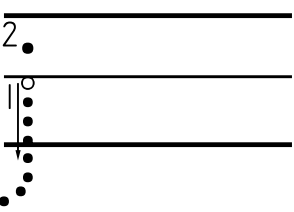
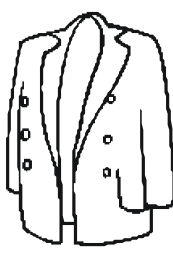
j  



k  

# Beginning Consonants

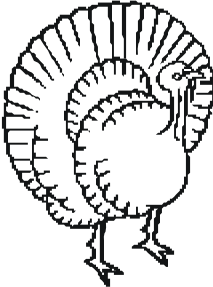

Say the letter at the beginning of each row. Trace the letter and then write the letter on the line.

Color the picture that begins with the sound of the letter in each row.

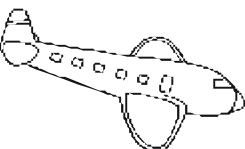
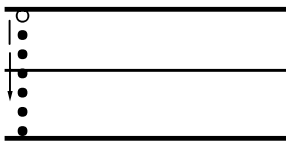

l



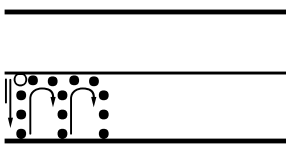

m

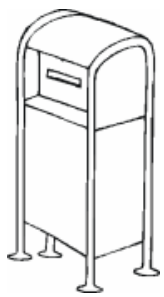

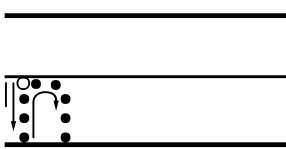
n

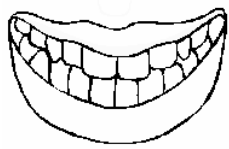

p

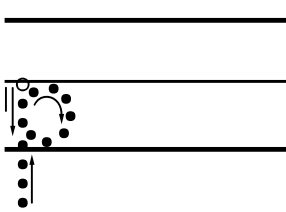

# Beginning Consonants



Say the letter at the beginning of each row. Trace the letter and then write the letter on the line.

Color the picture that begins with the sound of the letter in each row.

l



m



n

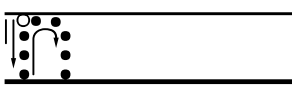

p





# Beginning Consonants

Say the letter at the beginning of each row. Trace the letter and then write the letter on the line.

Color the picture that begins with the sound of the letter in each row.

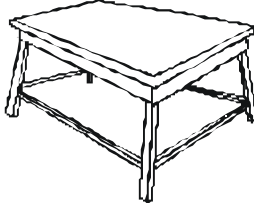

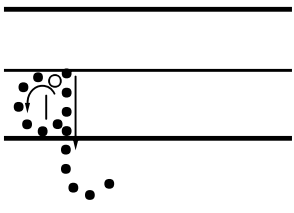
q



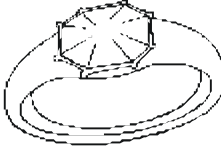
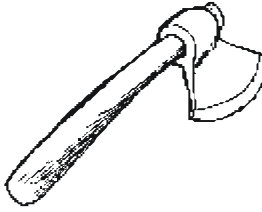
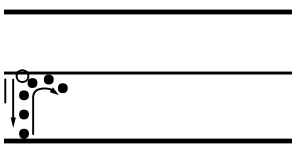

r

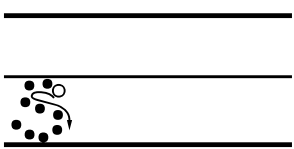

s

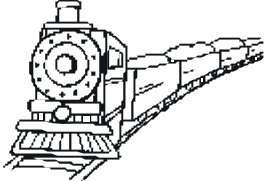

t

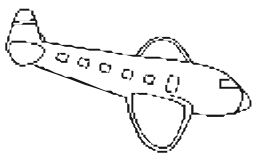
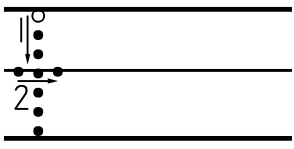

# Beginning Consonants

Say the letter at the beginning of each row. Trace the letter and then write the letter on the line.

Color the picture that begins with the sound of the letter in each row.

q

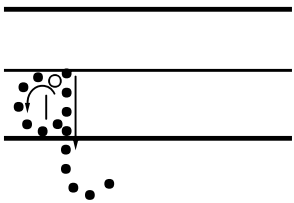

r

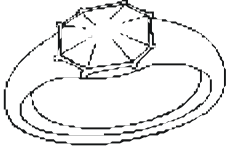
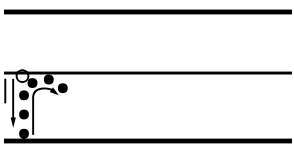

s

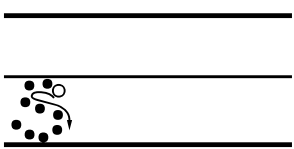

t

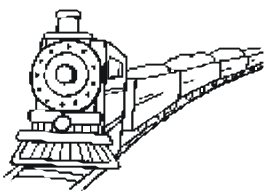
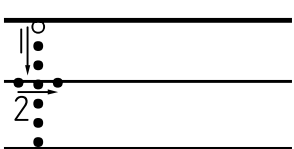



# Beginning Consonants

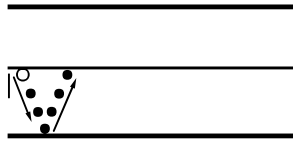
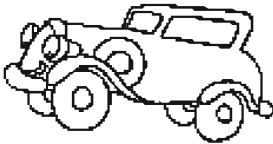

Say the letter at the beginning of each row. Trace the letter and then write the letter on the line.

Color the picture that begins with the sound of the letter in each row.



**V**

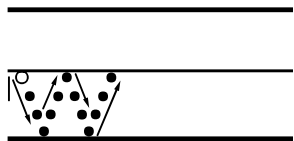
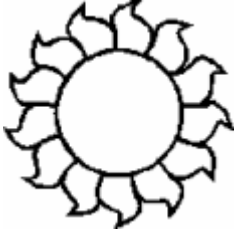

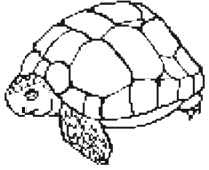

**W**

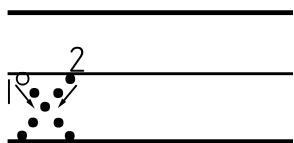
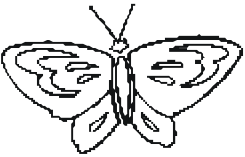

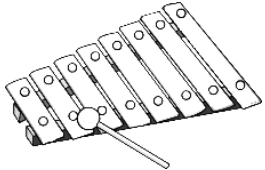
**X**

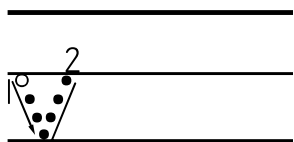
**Y**

**Z**



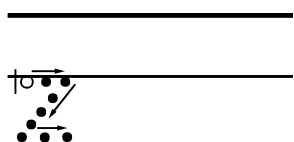
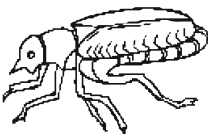

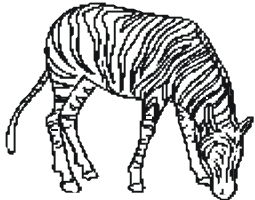

# Beginning Consonants

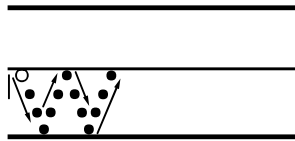

Say the letter at the beginning of each row. Trace the letter and then write the letter on the line.

Color the picture that begins with the sound of the letter in each row.

**v**  

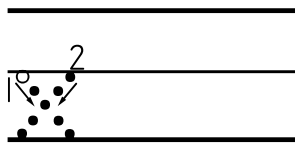
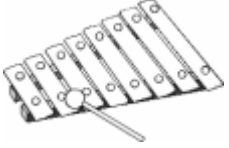
**w**  

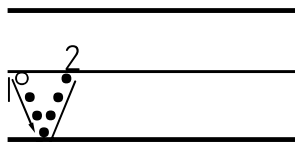
**x**  

**y**  

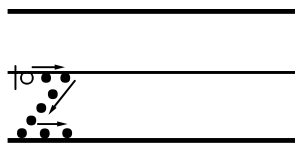
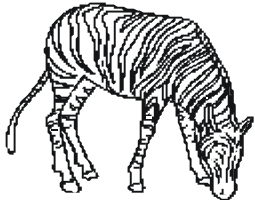
**z**  

## A note about the handwriting fonts used in this activity.

www.tlsbooks.com has purchased a license from <http://www.educationalfontware.com> that allows us to use their fonts for worksheets we produce.

The ZB Manuscript style font used in this document is a trademark of Educational Fontware, Inc (EFI).

The ZB Manuscript font is similar to Zaner-Bloser Simplified©-style font. ZB Manuscript font (by EFI) is not endorsed by Zaner-Bloser.

All worksheets are intended to supplement educational materials your child is currently using.